

WQV Submersible Electric Sewage Cutting Pump



Application

The WQV submersible sewage pump with cutter is mainly used for:

- (1) Construction sites, engineering foundation construction, municipal facilities
- (2) Sewage discharge from underground floors of various high-rise buildings such as basements, civil air defense pits, and subways
- (3) Wastewater treatment and circulating water transportation for small and medium-sized enterprises
- (4) Extraction of slurry from factories and mining enterprises such as food, paper-making, brewing, steel and non-ferrous metals, leather making, textiles, pharmaceuticals, cement plants, etc
- (5) The functions of poultry farms, pig farms, various animal husbandry industries, fish ponds for pumping and cleaning, septic tanks, and other occasions for transporting human and animal feces and urine

Product Overview

1. The WQ(D)V submersible sewage pump with cutter adopts an alloy cutter-head and impeller made of 20 chromium nickel molybdenum material, which has been heat-treated to enhance toughness. The design of a semi open impeller has a reasonable cutting structure and reasonable hydraulic characteristics, which maximizes the avoidance of water pump blockage, non entanglement, strong flow capacity, high head, and good cutting performance. It can crush impurities such as long fibers, plastics, paper, belts, cloth strips, straw, ropes, etc. in sewage and discharge them.
2. The designed submersible motor has IP68 protection level and F insulation class, with good diving cooling effect, low temperature rise, and long insulation life. Over-current protectors are installed below 7.5kW to ensure that the motor can automatically cut off power in case of abnormal situations.
3. It adopts a double end mechanical seal, with an external skeleton oil seal below 7.5kW, and a two to three series mechanical seals for motor shaft seals above 11kW, forming multiple reliable sealing lines. One is in the medium inside the pump, effectively preventing water from entering the oil chamber, and the other is in the oil chamber to prevent oil from entering the motor chamber. The oil chamber is filled with suitable mechanical oil, while lubricating and cooling the friction surfaces of the two independent machine seals, making the machine seal work more reliable. In addition, it can also take away the heat generated by the lower bearings and some heat generated by the motor.
4. Some water pumps have special cable manufacturing processes that can completely prevent water from entering the motor through the small gaps between the wires when the cable skin is damaged or the front end of the cable is submerged in water.

Operating Condition

1. Power supply: 50Hz, three-phase, 380V
2. Medium temperature: $\leq 40^{\circ}\text{C}$, volume ratio of solid matter transported by the medium: $< 2\%$, medium density: $< 1200\text{kg/m}^3$
3. During operation, the minimum liquid level should not be lower than 2/3 of the motor's
4. Unable to adapt to media with corrosive fluids and particles
5. The diameter of the solid object in the medium shall not exceed the maximum allowable solid diameter

Model Definition

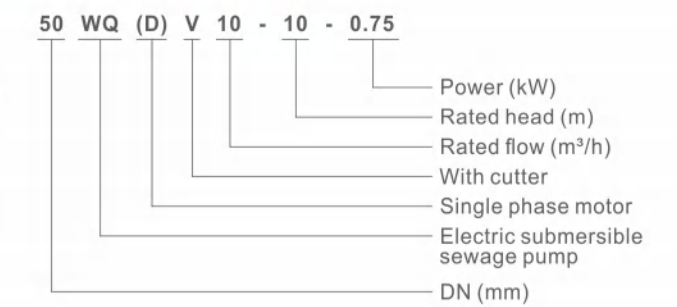

Performance Curve

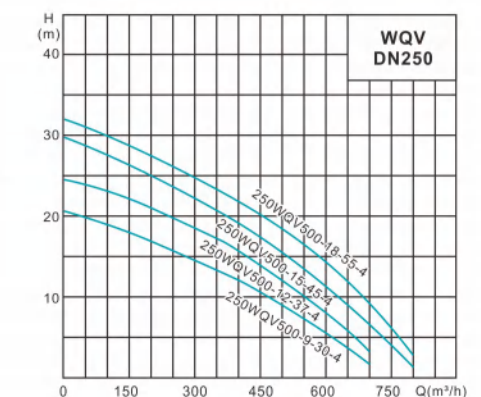
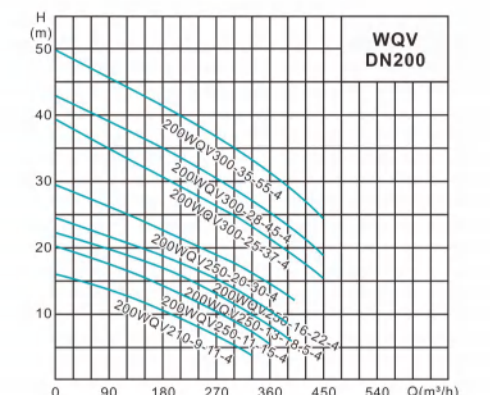
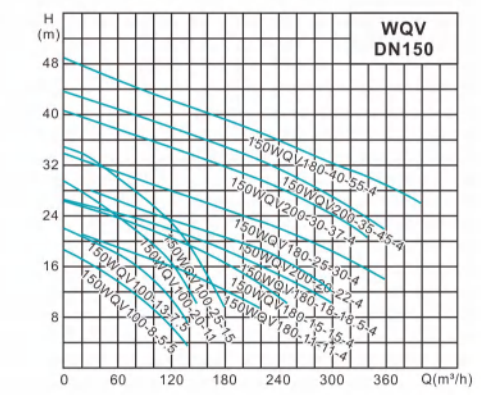
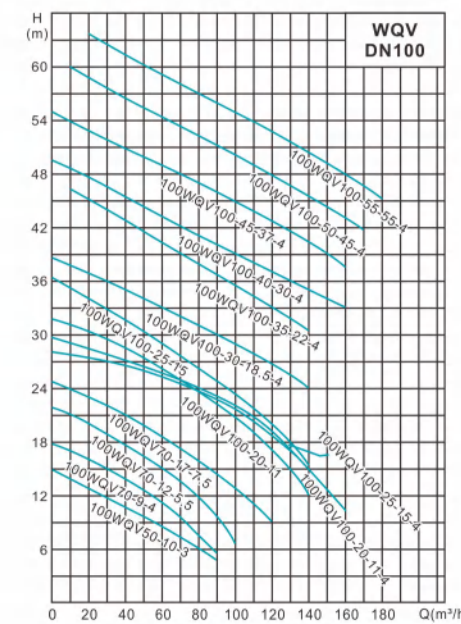
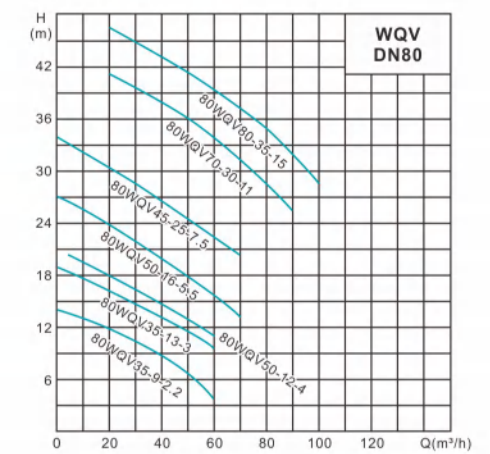
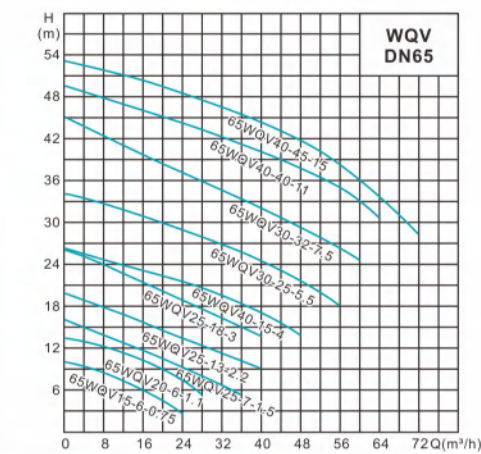
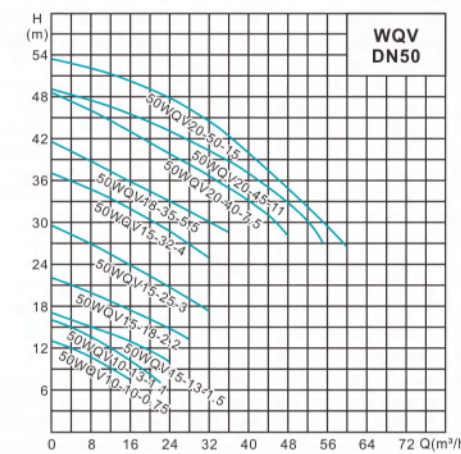

Performance Table

Model	Rate flow (m³/h)	Rate head (m)	Rate power (kW)	Rated voltage (V)	Outlet (mm)	Speed (r/min)
50WQDV10-10-0.75	10	10	0.75	220	50	2850
65WQDV15-7-0.75	15	7	0.75	220	65	2850
50WQDV10-13-1.1	10	13	1.1	220	50	2850
65WQDV15-10-1.1	15	10	1.1	220	65	2850
50WQDV15-13-1.5	15	13	1.5	220	50	2850
65WQDV25-10-1.5	25	10	1.5	220	65	2850
50WQDV15-18-2.2	15	18	2.2	220	50	2850
65WQDV25-13-2.2	25	13	2.2	220	65	2850
80WQDV35-9-2.2	35	9	2.2	220	80	2850
50WQV10-10-0.75	10	10	0.75	380	50	2850
65WQV15-7-0.75	15	7	0.75	380	65	2850
50WQV10-13-1.1	10	13	1.1	380	50	2850
65WQV15-10-1.1	15	10	1.1	380	65	2850
50WQV15-13-1.5	15	13	1.5	380	50	2850
65WQV25-10-1.5	25	10	1.5	380	65	2850
50WQV15-18-2.2	15	18	2.2	380	50	2850
65WQV25-13-2.2	25	13	2.2	380	65	2850
80WQV35-9-2.2	35	9	2.2	380	80	2850
50WQV15-25-3	15	25	3	380	50	2850
65WQV25-18-3	25	18	3	380	65	2850
80WQV35-13-3	35	13	3	380	80	2850
100WQV50-10-3	50	10	3	380	100	2850
50WQV15-32-4	15	32	4	380	50	2900
65WQV40-15-4	40	15	4	380	65	2900
80WQV50-12-4	50	12	4	380	80	2900
100WQV70-9-4	70	9	4	380	100	2900
50WQV18-35-5.5	18	35	5.5	380	50	2900
65WQV30-25-5.5	30	25	5.5	380	65	2900
80WQV50-16-5.5	50	16	5.5	380	80	2900
100WQV70-12-5.5	70	12	5.5	380	100	2900
150WQV100-8-5.5	100	8	5.5	380	150	2900
50WQV20-40-7.5	20	40	7.5	380	50	2900
65WQV30-32-7.5	30	32	7.5	380	65	2900
80WQV45-22-7.5	45	22	7.5	380	80	2900
100WQV70-17-7.5	70	17	7.5	380	100	2900
150WQV140-8-7.5	140	8	7.5	380	150	2900
50WQV20-45-11	20	45	11	380	50	2900
65WQV40-40-11	40	40	11	380	65	2900
80WQV60-30-11	60	30	11	380	80	2900
100WQV80-25-11	80	25	11	380	100	2900
150WQV100-20-11	100	20	11	380	150	2900
50WQV20-50-15	20	50	15	380	50	2900
65WQV40-45-15	40	45	15	380	65	2900
80WQV60-40-15	60	40	15	380	80	2900
100WQV80-35-15	80	35	15	380	100	2900
150WQV100-25-15	100	25	15	380	150	2900
100WQV100-20-11	100	20	11	380	100	1450
150WQV180-11-11	180	11	11	380	150	1450

Performance Table

Model	Rate flow (m³/h)	Rate head (m)	Rate power (kW)	Rated voltage (V)	Outlet (mm)	Speed (r/min)
200WQV210-9-11	210	9	11	380	200	1450
100WQV100-25-15	100	25	15	380	100	1450
150WQV180-15-15	180	15	15	380	150	1450
200WQV250-11-15	250	11	15	380	200	1450
100WQV100-30-18.5	100	30	18.5	380	100	1450
150WQV180-18-18.5	180	18	18.5	380	150	1450
200WQV250-13-18.5	250	13	18.5	380	200	1450
100WQV100-35-22	100	35	22	380	100	1450
150WQV200-20-22	200	20	22	380	150	1450
200WQV250-16-22	250	16	22	380	200	1450
100WQV100-40-30	100	40	30	380	100	1450
150WQV180-25-30	180	25	30	380	150	1450
200WQV250-22-30	250	22	30	380	200	1450
250WQV500-9-30	500	9	30	380	250	1450
100WQV100-45-37	100	45	37	380	100	1450
150WQV200-30-37	200	30	37	380	150	1450
200WQV300-25-37	300	25	37	380	200	1450
250WQV500-12-37	500	12	37	380	250	1450
100WQV100-50-45	100	50	45	380	100	1450
150WQV200-35-45	200	35	45	380	150	1450
200WQV300-30-45	300	30	45	380	200	1450
250WQV500-15-45	500	15	45	380	250	1450
100WQV100-55-55	100	55	55	380	100	1450
150WQV180-40-55	180	40	55	380	150	1450
200WQV300-35-55	300	35	55	380	200	1450
250WQV500-18-55	500	18	55	380	250	1450