



EBC Circulation Pump



Our pump has several different designs for customer chose. Each design is only the different of outlooking, no affection on performance and quality. All spare parts and material are the same. The popular model types are: G type, B type. Each design has its own housing and terminal box. pls check the photos as following.

Operating Condition

1. Apply to heating system
2. Max.system pressure: 10bar
3. Operation condition: Ambient Temperature: 0°C~40°C Ambient Humidity: 95% Liquid Temperature: -10°C~110°C
Ambient temperature must be lower than liquid temperature, in order to avoid condensate water produced in the interior of stator.
4. Liquid : Clean, non-coorosive and non-explosive liquids, without any particle, fiber or mineral oil.
Water/glycol mixtures max. mixing ratio: 1:1
5. Dry running no more than 10min.

Model Definition

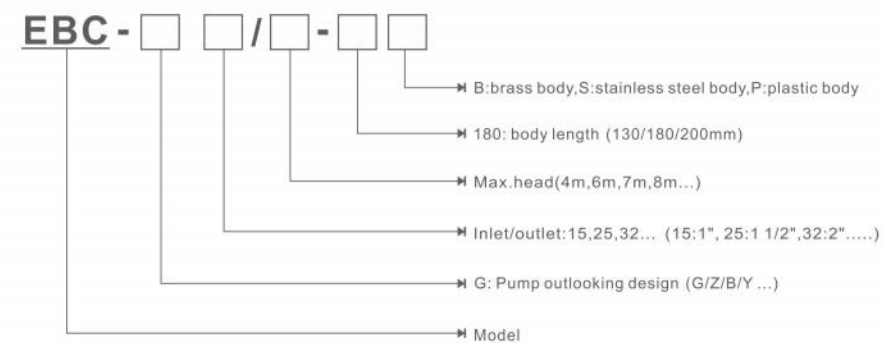

● Example: EBC-G 25/6-180 is small circulation pump with cast-iron body, 25inlet/outlet, 6m head, 180mm body length

Technical Data

Suitable fluids

- Heating water to VD12035
- Heating water
- Water/glycol mixtures max. mixing ratio 1:1

Performance

- Fluid temperature range -10°C~+110°C
- Max. working pressure 10bar

Ambient Temperature

- Permissible up to 40°C

Power

- Mains power 1~230v, 50Hz

Motor

- Degree of protection IP44
- Insulation class F

Construction Materials

Pump body	cast iron
Impeller	PP
Shaft	Ceramic
Bearings	Ceramic

Mounting Positions

Pump shaft in the horizontal plane

Pump Equipment

- Screwed end single head pump
- Manual 3-speed control
- Non-overloading single phase motor
- cast iron body, 180mm port-to-port
- cast iron body 130mm port-to-port



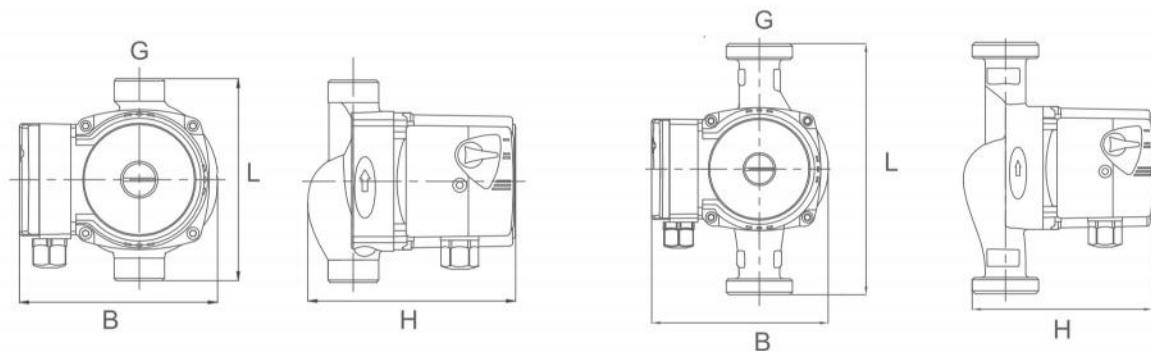

Performance Table

Model	Power	Max. flow (m ³ /h)	Max. head (m)	Voltage			Material of pump body			Dimension(mm)				Weight (Kg)
	(W)			220V/ 50Hz	220V/ 60Hz	127V/ 60Hz	Cast Iron	Brass	Stainless steel	L	B	H	G	
EBC15/4-130	72/53/38	2.3/1.7/0.8	4.5/4/3	●	●	●	●	●	130	127	133	1"	2.2	
EBC20/4-130		2.3/1.7/0.8										1 1/4"	2.2	
EBC25/4-130		2.9/2.1/1.3										1 1/2"	2.3	
EBC25/4-180		3.4/2.3/1.3										1 1/2"	2.4	
EBC32/4-180		3.4/2.3/1.3										2"	2.6	

Model	Power	Max. flow (m ³ /h)	Max. head (m)	Voltage			Material of pump body			Dimension(mm)				Weight (Kg)
	(W)			220V/ 50Hz	220V/ 60Hz	127V/ 60Hz	Cast Iron	Brass	Stainless steel	L	B	H	G	
EBC12/6-130	93/67/46	1.8/1.2/0.8	6/5/3	●	●	●	●	●	130	127	133	3/4"	2.1	
EBC15/6-130		2.6/2.0/1.2										1"	2.3	
EBC20/6-130		3.3/2.3/1.3										1 1/4"	2.4	
EBC25/6-130		3.3/2.3/1.3										1 1/2"	2.4	
EBC25/6-180		3.9/2.9/1.6										1 1/2"	2.5	
EBC32/6-180		3.9/2.9/1.6										2"	2.7	

EBC15/4

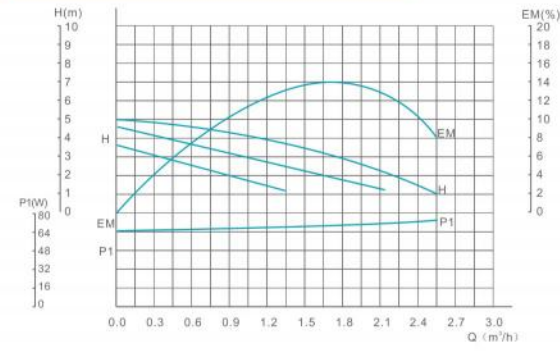

EBC25/4

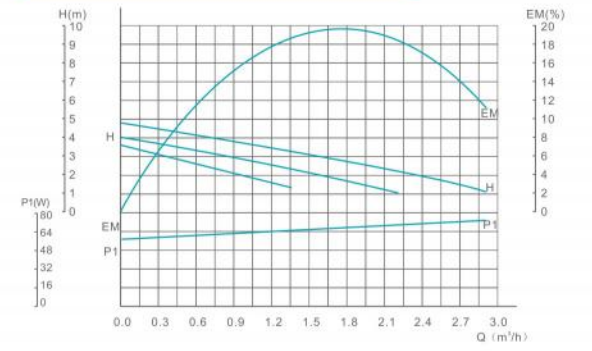

EBC32/4

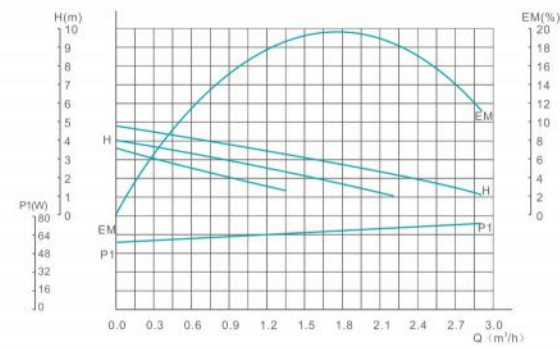

EBC12/6

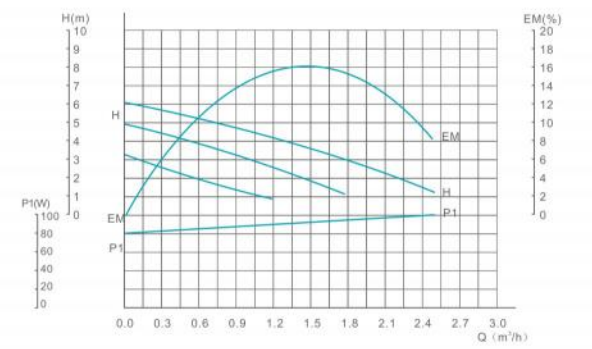

EBC15/6

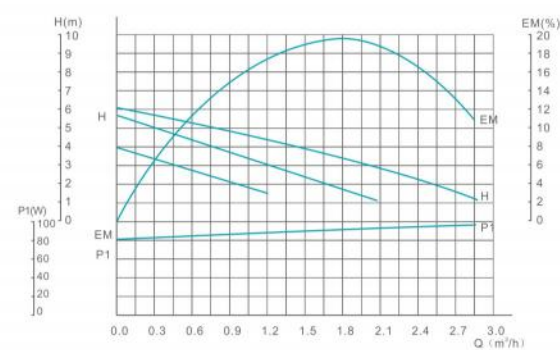

EBC20/6

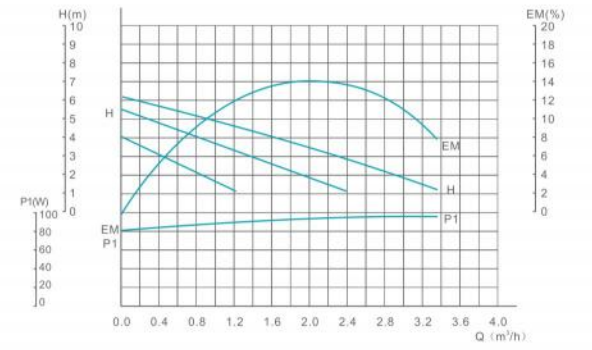

EBC25/6

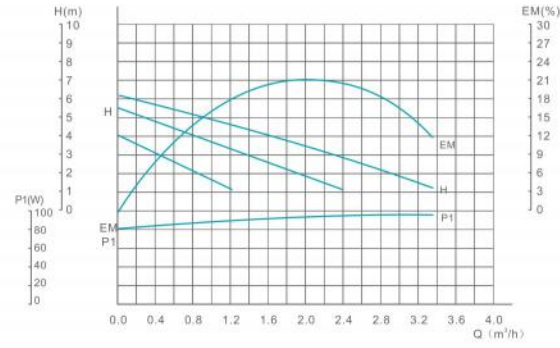

EBC32/6

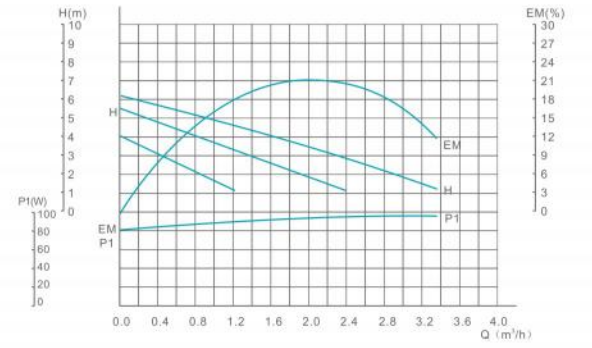



Performance Table

Model	Power	Max. flow (m ³ /h)	Max. head (m)	Voltage			Material of pump body			Dimension(mm)				Weight (Kg)
	(W)			220V/ 50Hz	220V/ 60Hz	127V/ 60Hz	Cast Iron	Brass	Stainless steel	L	B	H	G	
EBC15/7-130	125/93/67	3.3/2.7/1.3	7/6.5/4.5	●	●	●	●	●	●	130	123	145	1"	2.6
EBC25/7-130		3.8/3.0/1.9											1 1/2"	2.8
EBC25/7-180		4.1/3.2/2.1											2"	3.0
EBC32/7-180		4.2/3.4/2.2											2"	3.2

Model	Power	Max. flow (m ³ /h)	Max. head (m)	Voltage			Material of pump body			Dimension(mm)				Weight (Kg)
	(W)			220V/ 50Hz	220V/ 60Hz	127V/ 60Hz	Cast Iron	Brass	Stainless steel	L	B	H	G	
EBC25/8-180	182/170/145	6.9/5.7/2.7	8/7.5/6.5	●	●	●	●	●	●	180	134.5	158	1 1/2"	4.2
EBC32/8-180	270/210/150	9.6/6.2/2.5								180	137	172	2"	4.8

Model	Power	Max. flow (m ³ /h)	Max. head (m)	Voltage			Material of pump body			Dimension(mm)				Weight (Kg)
	(W)			220V/ 50Hz	220V/ 60Hz	127V/ 60Hz	Cast Iron	Brass	Stainless steel	L	B	H	G	
EBC20/12-180	245/220/145	3.1/1.9/1.3	12/11/7	●	●	●	●	●	●	180	150	152	1"	4.4
EBC25/12-180		3.7/2.2/1.3								180	150	160	1 1/2"	4.5

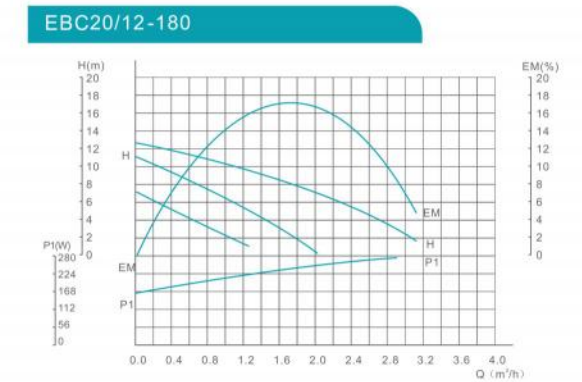
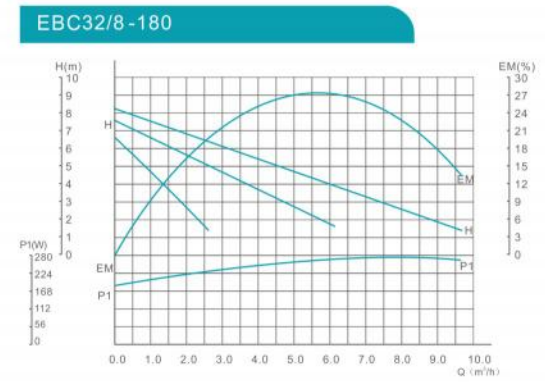
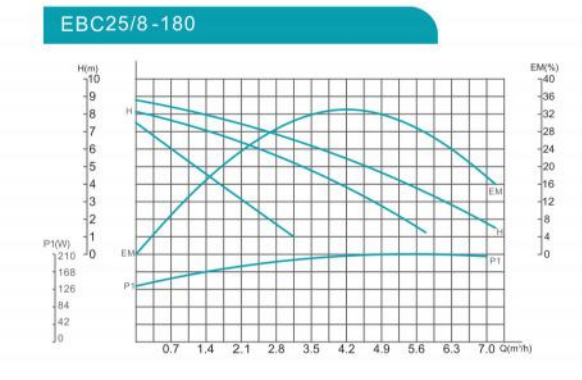
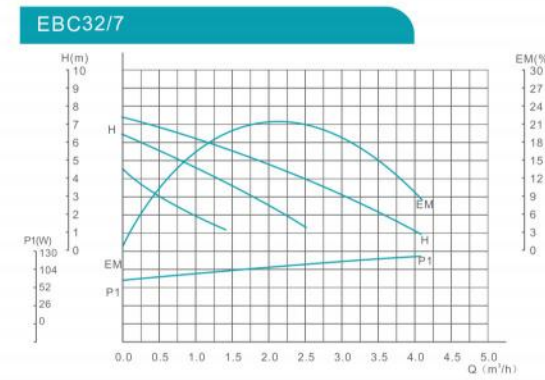
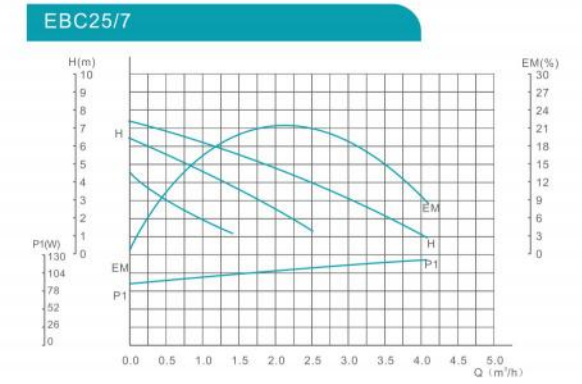
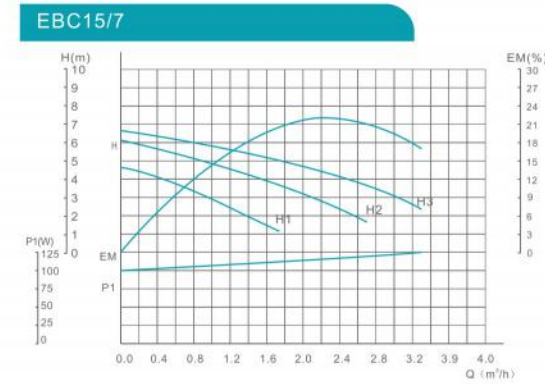

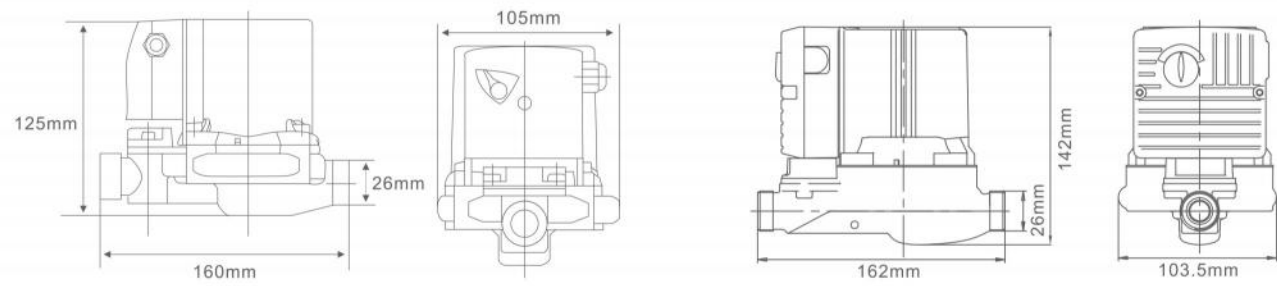

EBC-G 12/9(P/S/B)

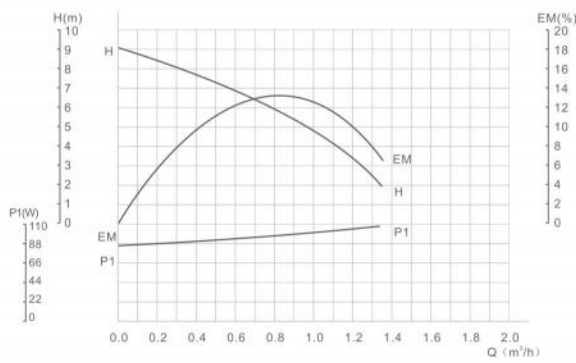

EBC-G 12/10(P/S/B)

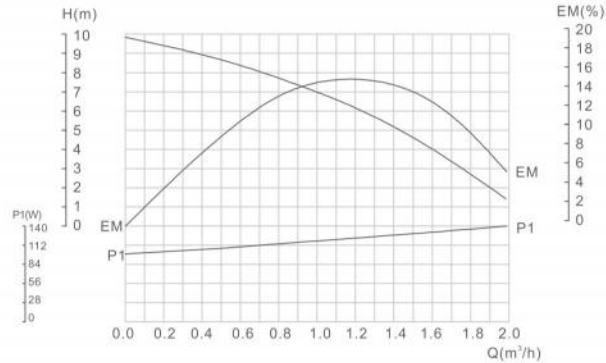

Performance Table

Model	Power (W)	Max. flow (m ³ /h)	Max. head (m)	Voltage			Pump housing design			Dimension(mm)				Weight (Kg)
				220V/50HZ	220V/60HZ	127V/60HZ	G type	T type	E type	L	B	H	G	
EBC-G 12/9	105	1.38	9	●	●	●	●	●	●	160	105	125	3/4"	2.4
EBC-G 12/9P				2.2										
EBC-G 12/9S				2.4										
EBC-G 12/9B				2.6										
EBC-G 12/10	140	1.8	10	●	●	●	●	●	●	162	103.5	142	3/4"	2.8
EBC-G 12/10P				2.6										
EBC-G 12/10S				2.8										
EBC-G 12/10B				3.0										

EBC-Z 20/12(S)

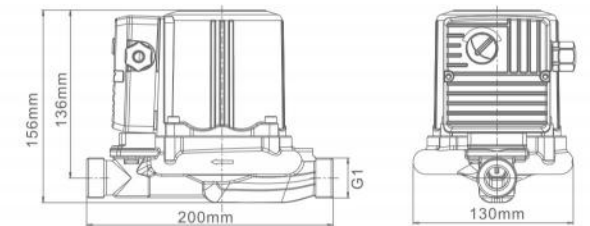
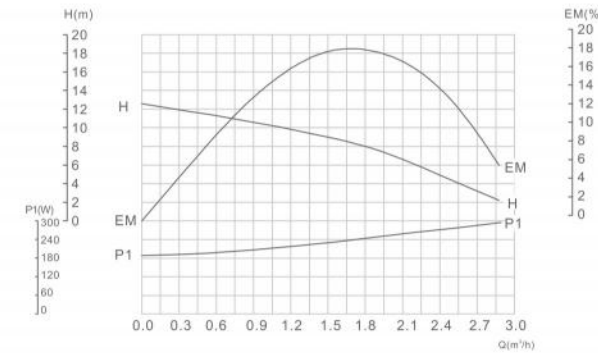

Performance Table

Model	Power (W)	Max. flow (m ³ /h)	Max. head (m)	Voltage			Pump housing design			Dimension(mm)				Weight (Kg)
				220V/50HZ	220V/60HZ	127V/60HZ	G type	T type	E type	L	B	H	G	
EBC-Z 20/12	275	3.1	12	●	●	●	●	●	●	200	130	156	1"	4.5
EBC-Z 20/12S				4.3										